

ALL DIMENSIONS IN INCHES

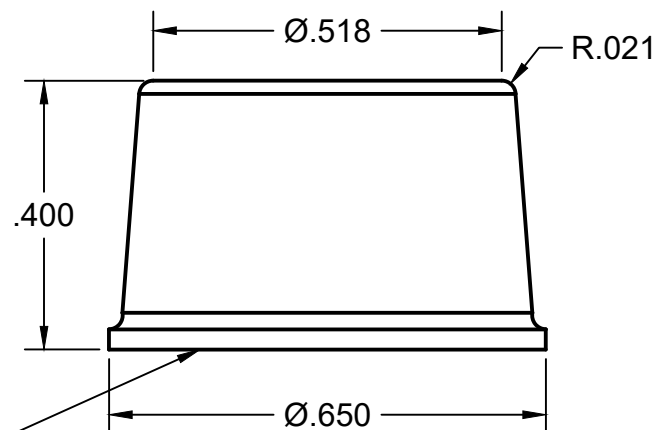

Pressure-Sensitive Adhesive

Nominal web thickness = 0.030"

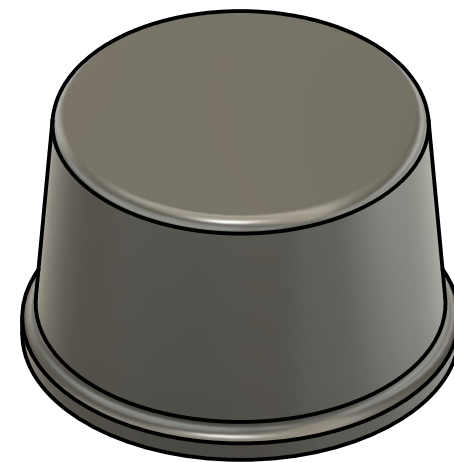
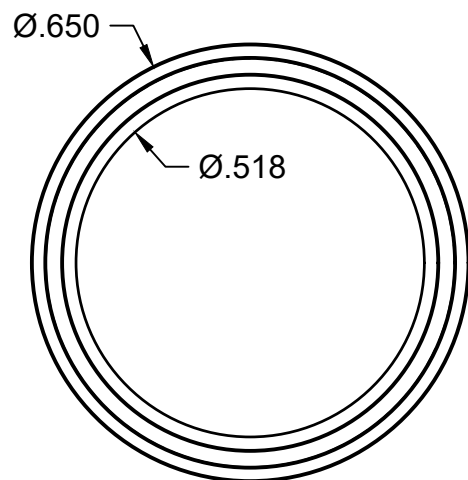

**MADE IN
THE USA**

COMPANY
Bumper Specialties, Inc.
1607 Imperial Way, West Deptford, NJ 08066
(856)-345-7650
www.BumperSpecialties.com

TOLERANCE ± 0.020"	DUROMETER, SHORE A 60-70 Standard	MATERIAL Polyurethane	
PART NO BS11	DRAWN 11/11/19	REV 1	SHEET 1 of 1