

ALL DIMENSIONS IN INCHES

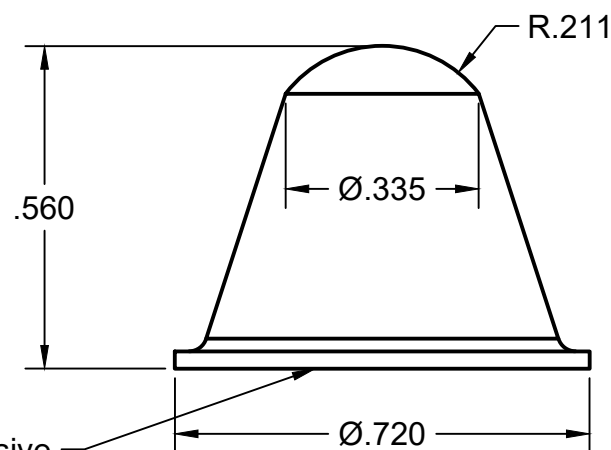

Pressure-Sensitive Adhesive

Nominal web thickness = 0.030"

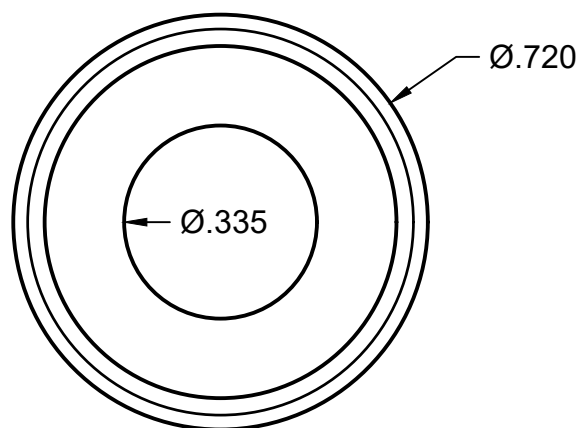

**MADE IN  
THE USA**

COMPANY  
Bumper Specialties, Inc.  
1607 Imperial Way, West Deptford, NJ 08066  
(856)-345-7650  
www.BumperSpecialties.com

TOLERANCE ± 0.020"	DUROMETER, SHORE A 60-70 Standard	MATERIAL Polyurethane
<b>PART NO BS37</b>	<b>DRAWN 11/11/19</b>	<b>REV 1</b>
		<b>SHEET 1 of 1</b>